

brc

PLASTİK



2023 PLASTİK ÜRÜNLER KATALOĞU

Plastic Products Catalog

R-KLT ve RL-KLT Kasalar

PPC'den üretilen KLT kasa serisi yüksek dayanma gücüne sahip olmakla birlikte otomotiv, yan sanayi, ağır sanayi ve birçok sektörde kullanılmaktadır. R-KLT (güçlü taban) ve RL-KLT (düz taban) olmak üzere iki taban seçeneği ile üretilmektedir.

El tutma yerleri kapalı olması sayesinde güvenli taşınabilmekte ve kanban etiket yuvası bulunmaktadır üst üste istiflenerek depolamada ürünlerinizde kolay ve hızlı ulaşmanızı sağlar.

R-KLT & RL-KLT Crates

The KLT crate series are produced from PPC and have high durability. They are used in automotive, sub-industry, heavy industry and many other sectors. R-KLT (reinforced base), RL-KLT flat bottom are produced with two base options. With closed hand grips, crates are moved safely and have kanban label holders on them. They are stacked easily in order you to reach products safely and easily in the warehouses.



Güçlendirilmiş Taban
Reinforcement Base



Düz Taban
Flat Base

R-KLT-3215

En/W Boy/L Yük/H

Dış / Ext 200 x 300 x 147 mm
İç / İnt 170 x 245 x 125 mm

RL-KLT-3147

En/W Boy/L Yük/H

Dış / Ext 200 x 300 x 147 mm
İç / İnt 170 x 245 x 143 mm

R-KLT-4315

En/W Boy/L Yük/H

Dış / Ext 300 x 400 x 147 mm
İç / İnt 265 x 340 x 120 mm

RL-KLT-4147

En/W Boy/L Yük/H

Dış / Ext 300 x 400 x 147 mm
İç / İnt 265 x 340 x 143 mm

R-KLT-4322

En/W Boy/L Yük/H

Dış / Ext 300 x 400 x 215 mm
İç / İnt 265 x 340 x 195 mm

RL-KLT-4213

En/W Boy/L Yük/H

Dış / Ext 300 x 400 x 215 mm
İç / İnt 265 x 340 x 211 mm

R-KLT-4329

En/W Boy/L Yük/H

Dış / Ext 300 x 400 x 280 mm
İç / İnt 265 x 340 x 255 mm

RL-KLT-4280

En/W Boy/L Yük/H

Dış / Ext 300 x 400 x 280 mm
İç / İnt 265 x 340 x 276 mm

R-KLT-6415

En/W Boy/L Yük/H

Dış / Ext 400 x 600 x 147 mm
İç / İnt 364 x 544 x 109 mm

RL-KLT-6147

En/W Boy/L Yük/H

Dış / Ext 400 x 600 x 147 mm
İç / İnt 364 x 544 x 143 mm

R-KLT-6422

En/W Boy/L Yük/H

Dış / Ext 400 x 600 x 215 mm
İç / İnt 364 x 544 x 195 mm

RL-KLT-6213

En/W Boy/L Yük/H

Dış / Ext 400 x 600 x 215 mm
İç / İnt 364 x 544 x 211 mm

R-KLT-6429

En/W Boy/L Yük/H

Dış / Ext 400 x 600 x 280 mm
İç / İnt 364 x 544 x 255 mm

RL-KLT-6280

En/W Boy/L Yük/H

Dış / Ext 400 x 600 x 280 mm
İç / İnt 364 x 544 x 276 mm

R-KLT-6436

En/W Boy/L Yük/H

Dış / Ext 400 x 600 x 360 mm
İç / İnt 364 x 544 x 335 mm

RL-KLT-6236

En/W Boy/L Yük/H

Dış / Ext 400 x 600 x 360 mm
İç / İnt 364 x 544 x 356 mm

400 x 600 mm Kapalı Kasalar

Kapalı kasalar sağlam yapısı sayesinde ürünlerinizi güvende taşımanızı , depolamanızı ve istiflemenizi sağlar. Farklı ebat, renk ve taban seçenekleri ile PPC'den üretilen kapalı kasalar isteğe göre el tutma yeri açık veya kapalı olarak tercih edilebilirler.

400 x 600 mm Solid Crates

The solid crates allow you to carry and store your products safely with their robust structure. PPC solid crates have different size, color, base, open hand grip, closed hand grip options.



Kapalı Taban
Closed Base



Düz Taban
Flat Base



Kod / Code **HP-6503**
En/W Boy/L Yük/H
Dış / Ext 400 x 600 x 65 mm
İç / İnt 365 x 565 x 53 mm



Kod / Code **HP-1003**
En/W Boy/L Yük/H
Dış / Ext 400 x 600 x 100 mm
İç / İnt 365 x 565 x 88 mm



Kod / Code **HP-1203**
En/W Boy/L Yük/H
Dış / Ext 400 x 600 x 120 mm
İç / İnt 365 x 565 x 108 mm



Kod / Code **HP-1503**
En/W Boy/L Yük/H
Dış / Ext 400 x 600 x 150 mm
İç / İnt 365 x 565 x 138 mm



Kod / Code **HP-1703**
En/W Boy/L Yük/H
Dış / Ext 400 x 600 x 170 mm
İç / İnt 365 x 565 x 158 mm



Kod / Code **HP-2003**
En/W Boy/L Yük/H
Dış / Ext 400 x 600 x 200 mm
İç / İnt 365 x 565 x 188 mm



Kod / Code **HP-2303**
En/W Boy/L Yük/H
Dış / Ext 400 x 600 x 230 mm
İç / İnt 365 x 565 x 218 mm



Kod / Code **HP-2803**
En/W Boy/L Yük/H
Dış / Ext 400 x 600 x 280 mm
İç / İnt 365 x 565 x 268 mm

HP-6504
En/W Boy/L Yük/H
400 x 600 x 65 mm
365 x 565 x 53 mm

HP-1004
En/W Boy/L Yük/H
400 x 600 x 100 mm
365 x 565 x 88 mm

HP-1204
En/W Boy/L Yük/H
400 x 600 x 120 mm
365 x 565 x 108 mm

HP-1504
En/W Boy/L Yük/H
400 x 600 x 150 mm
365 x 565 x 138 mm

HP-1704
En/W Boy/L Yük/H
400 x 600 x 170 mm
365 x 565 x 158 mm

HP-2004
En/W Boy/L Yük/H
400 x 600 x 200 mm
365 x 565 x 188 mm

HP-2304
En/W Boy/L Yük/H
400 x 600 x 230 mm
365 x 565 x 218 mm

HP-2804
En/W Boy/L Yük/H
400 x 600 x 280 mm
365 x 565 x 268 mm

400 x 600 mm Delikli Kasalar

Delikli plastik kasalar Meyve, Sebze, Narenciye taşımacılığı, Gıda, Tarım, Market, Sanayi ve bir çok sektörde kullanılmaktadır. Farklı ebat, renk ve taban seçenekleri ile PPC'den üretilen delikli kasalar isteğe göre el tutma yeri açık veya kapalı olarak tercih edebilirler.

400 x 600 mm Perforated Crates

Perforated plastic crates are used in fruits, vegetables, citrus transportation and food, agriculture, market sectors and in many other industries. PPC solid crates have different size, color, base, open hand grip, closed hand grip options.

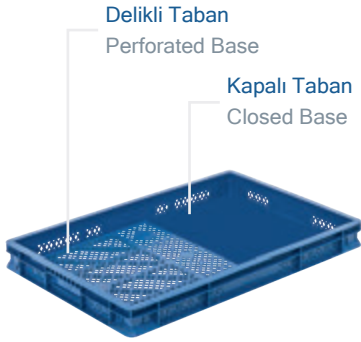

Delikli Taban
Perforated Base

Kapalı Taban
Closed Base

HP-6501
En/W Boy/L Yük/H
Dış / Ext 400 x 600 x 65 mm
İç / Int 365 x 565 x 53 mm

HP-6502
En/W Boy/L Yük/H
Dış / Ext 400 x 600 x 65 mm
İç / Int 365 x 565 x 53 mm

HP-1001
En/W Boy/L Yük/H
Dış / Ext 400 x 600 x 100 mm
İç / Int 365 x 565 x 88 mm

HP-1002
En/W Boy/L Yük/H
Dış / Ext 400 x 600 x 100 mm
İç / Int 365 x 565 x 88 mm

HP-1501
En/W Boy/L Yük/H
Dış / Ext 400 x 600 x 150 mm
İç / Int 365 x 565 x 137 mm

HP-1502
En/W Boy/L Yük/H
Dış / Ext 400 x 600 x 150 mm
İç / Int 365 x 565 x 137 mm

HP-2001
En/W Boy/L Yük/H
Dış / Ext 400 x 600 x 200 mm
İç / Int 365 x 565 x 188 mm

HP-2002
En/W Boy/L Yük/H
Dış / Ext 400 x 600 x 200 mm
İç / Int 365 x 565 x 188 mm

HP-2301
En/W Boy/L Yük/H
Dış / Ext 400 x 600 x 230 mm
İç / Int 365 x 565 x 218 mm

HP-2302
En/W Boy/L Yük/H
Dış / Ext 400 x 600 x 230 mm
İç / Int 365 x 565 x 218 mm

Yükseltme teraslı
Walls with terrace

HP-2005
En/W Boy/L Yük/H
Dış / Ext 400 x 600 x 200 mm
İç / Int 365 x 565 x 188 mm

HP-2006
En/W Boy/L Yük/H
Dış / Ext 400 x 600 x 200 mm
İç / Int 365 x 565 x 188 mm

Yükseltme teraslı
Walls with terrace

HP-2305
En/W Boy/L Yük/H
Dış / Ext 400 x 600 x 230 mm
İç / Int 365 x 565 x 218 mm

HP-2306
En/W Boy/L Yük/H
Dış / Ext 400 x 600 x 230 mm
İç / Int 365 x 565 x 218 mm



HP-3002
Kod / Code *En/W Boy/L Yük/H*
Dış / Ext 400 x 600 x 300 mm
İç / Int 365 x 565 x 284 mm



HP-3402
Kod / Code *En/W Boy/L Yük/H*
Dış / Ext 400 x 600 x 340 mm
İç / Int 365 x 565 x 324 mm



HP-3602
Kod / Code *En/W Boy/L Yük/H*
Dış / Ext 400 x 600 x 360 mm
İç / Int 365 x 565 x 342 mm

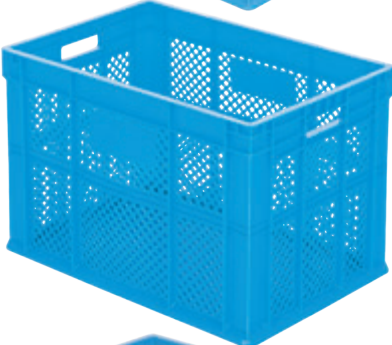

HP-4002
Kod / Code *En/W Boy/L Yük/H*
Dış / Ext 400 x 600 x 400 mm
İç / Int 365 x 565 x 386 mm



HP-4202
Kod / Code *En/W Boy/L Yük/H*
Dış / Ext 400 x 600 x 425 mm
İç / Int 365 x 565 x 410 mm



HP-4502
Kod / Code *En/W Boy/L Yük/H*
Dış / Ext 400 x 600 x 450 mm
İç / Int 365 x 565 x 436 mm

400 x 600 mm Kasalar

Delikli plastik kasalar Meyve, Sebze, Narenciye taşımacılığı, Gıda, Tarım, Market, Sanayi ve bir çok sektörde kullanılmaktadır. Farklı ebat, renk ve taban seçenekleri ile PPC'den üretilen delikli kasalar isteğe göre el tutma yeri açık veya kapalı olarak tercih edebilirler.

400 x 600 mm Crates

Perforated plastic crates are used in fruits, vegetables, citrus transportation and food, agriculture, market sectors and in many other industries. PPC solid crates have different size, color, base, open hand grip, closed hand grip options.

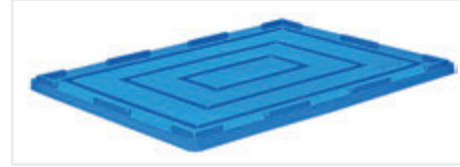

HP-40x60 *En/W Boy/L Yük/H*
Dış / Ext 400 x 600 x 20 mm
Kapak / Lid



HP-41x61 *En/W Boy/L Yük/H*
Dış / Ext 400 x 600 x 10 mm
Kapak / Lid



Kod / Code HP-3003
En/W Boy/L Yük/H
Dış / Ext 400 x 600 x 300 mm
İç / Int 365 x 565 x 284 mm



Kod / Code HP-3403
En/W Boy/L Yük/H
Dış / Ext 400 x 600 x 340 mm
İç / Int 365 x 565 x 324 mm

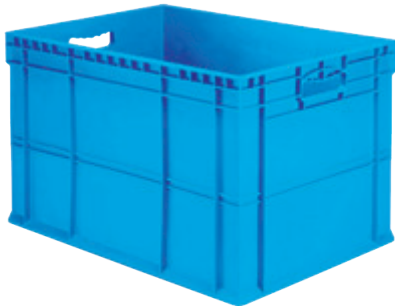

Kod / Code HP-3603
En/W Boy/L Yük/H
Dış / Ext 400 x 600 x 360 mm
İç / Int 365 x 565 x 342 mm

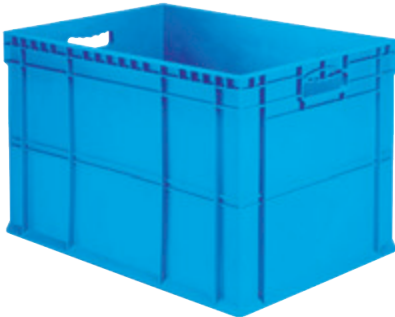

Kod / Code HP-4003
En/W Boy/L Yük/H
Dış / Ext 400 x 600 x 400 mm
İç / Int 365 x 565 x 386 mm

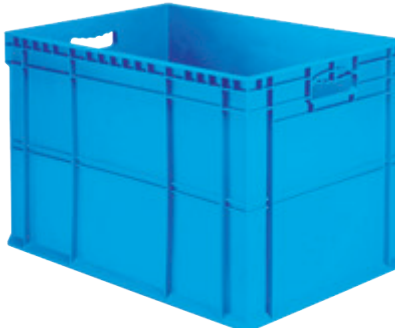

Kod / Code HP-4203
En/W Boy/L Yük/H
Dış / Ext 400 x 600 x 425 mm
İç / Int 365 x 565 x 410 mm



Kod / Code HP-4503
En/W Boy/L Yük/H
Dış / Ext 400 x 600 x 450 mm
İç / Int 365 x 565 x 436 mm

HP-2003-1

En/W Boy/L Yük/H
Dış / Ext 590 x 390 x 205 mm
İç / Int 560 x 360 x 195 mm



400 x 600 mm Kasalar

Kapalı kasalar sağlam yapısı sayesinde ürünlerinizi güvende taşımanızı, depolamanızı ve istiflemenizi sağlar. Farklı ebat, renk ve taban seçenekleri ile PPC'den üretilen kapalı kasalar iste göre el tutma yeri açık veya kapalı olarak tercih edebilirler.

400 x 600 mm Crates

The solid crates allow you to carry and store your products safely with their robust structure. PPC solid crates have different size, color, base, open hand grip, closed hand grip options.

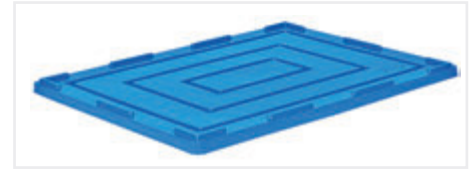

HP-40x60 *En/W Boy/L Yük/H*
Dış / Ext 400 x 600 x 20 mm
Kapak / Lid



HP-41x61 *En/W Boy/L Yük/H*
Dış / Ext 400 x 600 x 10 mm
Kapak / Lid

Sıvı birikimi için taban ortadan bombelidir.
The base is cambered from the middle for fluid accumulation

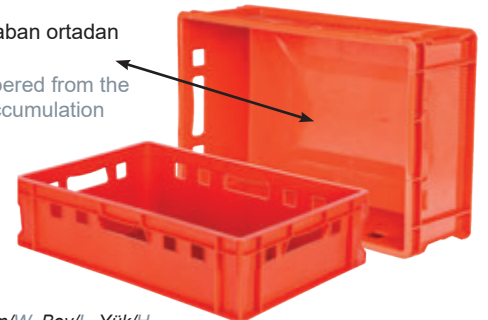

E-1 *En/W Boy/L Yük/H*
Dış / Ext 400 x 600 x 125 mm
İç / Int 370 x 570 x 110 mm

Sıvı birikimi için taban ortadan bombelidir.
The base is cambered from the middle for fluid accumulation

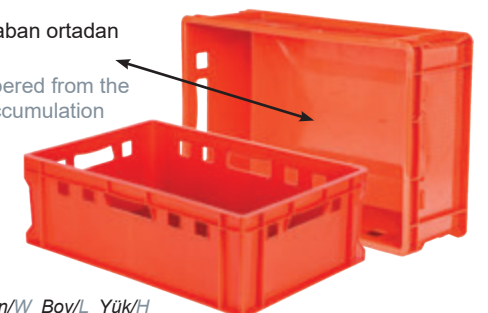

E-2 *En/W Boy/L Yük/H*
Dış / Ext 400 x 600 x 200 mm
İç / Int 370 x 570 x 110 mm

400 x 600 Önü Açık Kasalar
400 x 600 Open Front Crates



Kod / Code **HP-3402 AV**
En/W Boy/L Yük/H
Dış / Ext 400 x 600 x 340 mm
İç / Int 365 x 565 x 324 mm

Kod / Code **HP-3402 AVK**
En/W Boy/L Yük/H
Dış / Ext 400 x 600 x 340 mm
İç / Int 365 x 565 x 324 mm



Kod / Code **HP-3402 AVU**
En/W Boy/L Yük/H
Dış / Ext 400 x 600 x 340 mm
İç / Int 365 x 565 x 324 mm

Kod / Code **HP-3403 AVU**
En/W Boy/L Yük/H
Dış / Ext 400 x 600 x 340 mm
İç / Int 365 x 565 x 324 mm



Kod / Code **HP-4202 AV**
En/W Boy/L Yük/H
Dış / Ext 400 x 600 x 425 mm
İç / Int 365 x 565 x 410 mm

Kod / Code **HP-4202 AVK**
En/W Boy/L Yük/H
Dış / Ext 400 x 600 x 425 mm
İç / Int 365 x 565 x 410 mm



Kod / Code **HP-4202 AVU**
En/W Boy/L Yük/H
Dış / Ext 400 x 600 x 425 mm
İç / Int 365 x 565 x 410 mm

Kod / Code **HP-4203 AVU**
En/W Boy/L Yük/H
Dış / Ext 400 x 600 x 425 mm
İç / Int 365 x 565 x 410 mm



400 x 600 Önü Açık Kasalar
400 x 600 Open Front Crates



Kod / Code **HP-4622 AV**
En/W Boy/L Yük/H
Dış / Ext 400 x 600 x 220 mm
İç / İnt 365 x 565 x 205 mm



Kod / Code **HP-4628 AV**
En/W Boy/L Yük/H
Dış / Ext 400 x 600 x 280 mm
İç / İnt 365 x 565 x 268 mm



Kod / Code **HP-4634 AV**
En/W Boy/L Yük/H
Dış / Ext 400 x 600 x 340 mm
İç / İnt 365 x 565 x 325 mm



Kod / Code **AX-3403-AVK**
En/W Boy/L Yük/H
Dış / Ext 400 x 600 x 340 mm
İç / İnt 365 x 570 x 330 mm



Kod / Code **HP-4642 AV**
En/W Boy/L Yük/H
Dış / Ext 400 x 600 x 425 mm
İç / İnt 365 x 565 x 410 mm



Kod / Code **AX-4203 AVK**
En/W Boy/L Yük/H
Dış / Ext 400 x 600 x 425 mm
İç / İnt 365 x 570 x 415 mm



Kod / Code **HP-4645 AV**
En/W Boy/L Yük/H
Dış / Ext 400 x 600 x 450 mm
İç / İnt 365 x 565 x 436 mm

Delikli Kasaları
Perforated Crates



E-24
Kod / Code *En/W Boy/L Yük/H*
Dış / Ext 370 x 520 x 180 mm
İç / Int 340 x 490 x 160 mm



A-600-B
Kod / Code *En/W Boy/L Yük/H*
Dış / Ext 365 x 525 x 315 mm
İç / Int 340 x 500 x 310 mm



B-550-K
Kod / Code *En/W Boy/L Yük/H*
Dış / Ext 420 x 625 x 260 mm
İç / Int 380 x 580 x 240 mm



E-35
Kod / Code *En/W Boy/L Yük/H*
Dış / Ext 375 x 520 x 195 mm
İç / Int 340 x 490 x 180 mm



E-100
Kod / Code *En/W Boy/L Yük/H*
Dış / Ext 300 x 400 x 120 mm
İç / Int 285 x 360 x 110 mm



AX-850
Kod / Code *En/W Boy/L Yük/H*
Dış / Ext 444 x 634 x 150 mm
İç / Int 435 x 620 x 134 mm



E-5421
Kod / Code *En/W Boy/L Yük/H*
Dış / Ext 400 x 500 x 210 mm
İç / Int 370 x 470 x 200 mm



E-6430
Kod / Code *En/W Boy/L Yük/H*
Dış / Ext 400 x 600 x 310 mm
İç / Int 370 x 570 x 300 mm



E-6440
Kod / Code *En/W Boy/L Yük/H*
Dış / Ext 400 x 600 x 410 mm
İç / Int 370 x 570 x 400 mm



GK-910
Kod / Code *En/W Boy/L Yük/H*
Dış / Ext 425 x 655 x 390 mm
İç / Int 395 x 635 x 380 mm



400 X 600 mm Sanayi Kasaları
400 X 600 mm Industrial Crates



Kod / Code HP-4615
En/W Boy/L Yük/H
Dış / Ext 400 x 600 x 145 mm
İç / Int 360 x 560 x 130 mm



Kod / Code HP-4617
En/W Boy/L Yük/H
Dış / Ext 400 x 600 x 170 mm
İç / Int 360 x 560 x 155 mm



Kod / Code HP-4622
En/W Boy/L Yük/H
Dış / Ext 400 x 600 x 220 mm
İç / Int 360 x 560 x 205 mm



Kod / Code HP-4628
En/W Boy/L Yük/H
Dış / Ext 400 x 600 x 280 mm
İç / Int 360 x 560 x 265 mm



Kod / Code HP-4632
En/W Boy/L Yük/H
Dış / Ext 400 x 600 x 325 mm
İç / Int 360 x 560 x 310 mm



Kod / Code HP-4642
En/W Boy/L Yük/H
Dış / Ext 400 x 600 x 425 mm
İç / Int 360 x 560 x 410 mm



Kod / Code HP-4650
En/W Boy/L Yük/H
Dış / Ext 400 x 600 x 500 mm
İç / Int 360 x 560 x 485 mm



Güçlendirilmiş taban
Reinforced base



El korumalı tutamak
Hand protected grip

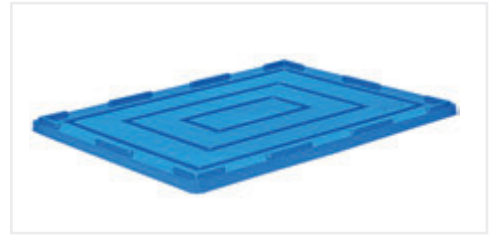

HP-40x60 *En/W Boy/L Yük/H*
Dış / Ext 400 x 600 x 20 mm
Kapak / Lid



Teker Takılabilir
Optional wheels



Aksesuarlar
Accessories



HP-41x61 En/W Boy/L Yük/H
Dış / Ext 400 x 600 x 10 mm
400 X 600 mm Kapak / Lid



AX-40x60 En/W Boy/L Yük/H
Dış / Ext 400 x 600 x 20 mm
400 X 600 mm Kapak / Lid



HP-34x54 En/W Boy/L Yük/H
Dış / Ext 340 x 540 x 10 mm
Yatay Separatör
Horizontal Separates



T-50 50x75 mm
Tekerlek / Wheel
HP-4615, HP-4617
HP-4622, HP-4628



T-75 75x105 mm
Tekerlek / Wheel
HP-4632, HP-4642
HP-4650, HP-6943-K



Dolly 4060
En/W Boy/L Yük/H
Kod / Code
Dış / Ext 420 x 600 x 190 mm
Plastik kasa taşıyıcı / Plastic crate carrier



Dolly 4262
En/W Boy/L Yük/H
Kod / Code
Dış / Ext 420 x 600 x 190 mm
Plastik kasa taşıyıcı / Plastic crate carrier



YM-4060
En/W Boy/L Yük/H
Kod / Code
Dış / Ext 420 x 620 x 150 mm
Metal Kasa Taşıyıcı
Metal dolly



Dolly 4161
En/W Boy/L Yük/H
Kod / Code
Dış / Ext 420 x 600 x 190 mm
Plastik kasa taşıyıcı / Plastic dolly



Kanban Yapıştırma Etiketler
Sticker kanban label holders

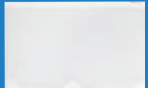

KANBAN 225x160
225 X 160 mm



KANBAN 225x90
225 X 90 mm



KANBAN 150x90
150 X 90 mm



KANBAN 110x110
110 X 110 mm



Dikey Separatörler
Upright separators

SPR-26 260X90 mm



SPR-39 356X90 mm



SPR-59 556X90 mm



SPR-2618 260X185 mm



SPR-3618 356X185 mm



SPR-5618 556X185 mm



SPR-3615 352X150 mm



SPR-5615 555X150 mm



400 X 600 mm Mentеше Kapaklı Kasalar
400 X 600 mm Industrial Crates With Hinged Lids



Kod / Code HP-4615 MK
En/W Boy/L Yük/H
Dış / Ext 400 x 600 x 165 mm
İç / Int 360 x 560 x 130 mm



Kod / Code HP-4617 MK
En/W Boy/L Yük/H
Dış / Ext 400 x 600 x 190 mm
İç / Int 360 x 560 x 155 mm



Kod / Code HP-4622 MK
En/W Boy/L Yük/H
Dış / Ext 400 x 600 x 240 mm
İç / Int 360 x 560 x 205 mm



Kod / Code HP-4628 MK
En/W Boy/L Yük/H
Dış / Ext 400 x 600 x 300 mm
İç / Int 360 x 560 x 265 mm



Kod / Code HP-4632 MK
En/W Boy/L Yük/H
Dış / Ext 400 x 600 x 345 mm
İç / Int 360 x 560 x 310 mm



Kod / Code HP-4642 MK
En/W Boy/L Yük/H
Dış / Ext 400 x 600 x 445 mm
İç / Int 360 x 560 x 410 mm



Kod / Code HP-4650 MK
En/W Boy/L Yük/H
Dış / Ext 400 x 600 x 520 mm
İç / Int 360 x 560 x 485 mm



Güçlendirilmiş taban
Reinforced base



El korumalı tutamak
Hand protected grip



Teker Takılabilir
Optional wheels



480x690 mm Kasaları
480x690 mm Crates



Kod / Code **HP-6943-A**
En/W Boy/L Yük/H
Dış / Ext 480 x 690 x 430 mm
İç / İnt 440 x 650 x 420 mm



Kod / Code **HP-6943-K**
En/W Boy/L Yük/H
Dış / Ext 480 x 690 x 430 mm
İç / İnt 440 x 650 x 420 mm



Kod / Code **HP-6943-AT**
En/W Boy/L Yük/H
Dış / Ext 480 x 690 x 540 mm
İç / İnt 440 x 650 x 420 mm



Kod / Code **HP-6943-KT**
En/W Boy/L Yük/H
Dış / Ext 480 x 690 x 540 mm
İç / İnt 440 x 650 x 420 mm



Kod / Code **HP-6943-MK**
En/W Boy/L Yük/H
Dış / Ext 480 x 690 x 455 mm
İç / İnt 440 x 650 x 420 mm



Kod / Code **HP-6943-MKT**
En/W Boy/L Yük/H
Dış / Ext 480 x 690 x 555 mm
İç / İnt 440 x 650 x 420 mm



Kod / Code **HP-6943-AV**
En/W Boy/L Yük/H
Dış / Ext 480 x 690 x 430 mm
İç / İnt 440 x 650 x 420 mm



Kod / Code **HP-43X69**
En/W Boy/L Yük/H
Dış / Ext 480 x 690 x 25 mm
480 x 690 mm Kapak / Lid



Sanayi Kasaları
Industrial Crates



Güçlendirilmiş Taban
Reinforced Base

Düz Taban
Flat Base



Kod / Code
Dış / Ext
İç / İnt

H-2111
En/W Boy/L Yük/H
148 x 200 x 120 mm
114 x 164 x 114 mm



Kod / Code
Dış / Ext
İç / İnt

H-3211 F
En/W Boy/L Yük/H
200 x 300 x 120 mm
162 x 262 x 103 mm

H-3211 D
En/W Boy/L Yük/H
200 x 300 x 120 mm
162 x 262 x 115 mm



Kod / Code
Dış / Ext
İç / İnt

H-3220 F
En/W Boy/L Yük/H
200 x 300 x 200 mm
162 x 262 x 185 mm



Kod / Code
Dış / Ext
İç / İnt

H-3220 AV
En/W Boy/L Yük/H
195 x 295 x 200 mm
160 x 255 x 185 mm



H-3220 BL
Kod / Code En/W Boy/L Yük/H
Dış / Ext 158 x 75 x 3 mm
Şeffaf Pencere
transparent window

HP-20x30 Kapak / Lid
En/W Boy/L Yük/H
200 x 300 x 10 mm
Kapak / Lid

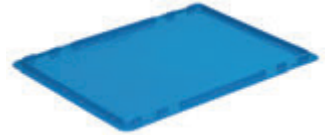

KN-1322
Kod / Code En/W Boy/L Yük/H
Dış / Ext 296 x 996 x 213 mm
İç / İnt 262 x 962 x 211 mm

300x400 mm Kasaları
300x400 mm Crates



Güçlendirilmiş Taban
Reinforced Base



Düz Taban
Flat Base



Kod / Code
Dış / Ext
İç / İnt

HP-4311 D
En/W Boy/L Yük/H
295 x 395 x 117 mm
263 x 365 x 112 mm



Kod / Code
Dış / Ext
İç / İnt

HP-4316 F
En/W Boy/L Yük/H
295 x 395 x 174 mm
263 x 365 x 160 mm

HP-4316 D
En/W Boy/L Yük/H
295 x 395 x 174 mm
263 x 365 x 170 mm



Kod / Code
Dış / Ext
İç / İnt

HP-4316 AV
En/W Boy/L Yük/H
300 x 400 x 174 mm
263 x 365 x 160 mm



Kod / Code
Dış / Ext
İç / İnt

HP-4322 F
En/W Boy/L Yük/H
295 x 395 x 230 mm
263 x 365 x 215 mm

HP-4322 D
En/W Boy/L Yük/H
295 x 395 x 230 mm
263 x 365 x 225 mm



Kod / Code
Dış / Ext
İç / İnt

HP-4322 AV
En/W Boy/L Yük/H
295 x 395 x 230 mm
263 x 365 x 215 mm



Kod / Code
Dış / Ext
İç / İnt

HP-4329 F
En/W Boy/L Yük/H
295 x 395 x 290 mm
263 x 365 x 275 mm

HP-4329 D
En/W Boy/L Yük/H
295 x 395 x 290 mm
263 x 365 x 285 mm



Kod / Code
Dış / Ext
İç / İnt

HP-4329 AV
En/W Boy/L Yük/H
295 x 395 x 290 mm
263 x 365 x 275 mm

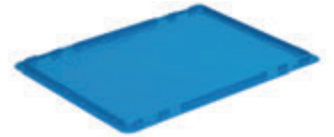

HP-30x40 Kapak / Lid
300 x 400 x 10 mm
300 x 400 Kapak / Lid

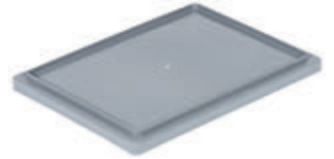

HP-31x41 Kapak / Lid
303 x 405 x 30 mm
300 x 400 Kapak / Lid

Sanayi Kasaları
Industrial Crates



Kod / Code **HP-160 K**
En/W Boy/L Yük/H
Dış / Ext 256 x 505 x 165 mm
İç / Int 224 x 470 x 150 mm



Kod / Code **HP-260 K**
En/W Boy/L Yük/H
Dış / Ext 256 x 505 x 221 mm
İç / Int 224 x 470 x 207 mm



Kod / Code **HP-18 K**
En/W Boy/L Yük/H
Dış / Ext 295 x 505 x 180 mm
İç / Int 260 x 470 x 207 mm



Kod / Code **HP-18-AV**
En/W Boy/L Yük/H
Dış / Ext 295 x 505 x 180 mm
İç / Int 260 x 470 x 162 mm



Kod / Code **HP-27-K**
En/W Boy/L Yük/H
Dış / Ext 295 x 505 x 235 mm
İç / Int 260 x 470 x 217 mm



Kod / Code **HP-27-AV**
En/W Boy/L Yük/H
Dış / Ext 295 x 505 x 235 mm
İç / Int 260 x 470 x 217 mm



Kod / Code **HP-270-K**
En/W Boy/L Yük/H
Dış / Ext 355 x 415 x 190 mm
İç / Int 330 x 385 x 175 mm

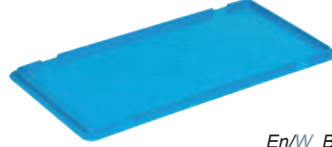

En/W Boy/L Yük/H
HP-26x50 256 x 505 x 10 mm
HP-160-K ve HP-260-K için kapak
Lid for HP-160-K and HP-260-K



En/W Boy/L Yük/H
HP-30x50 295 x 505 x 10 mm
HP-18-K ve HP-27-K Uyumlu kapak
Lid for HP-18-K and HP-27-K

Katlanır Kapalı Kasaları
Folding Solid Crates

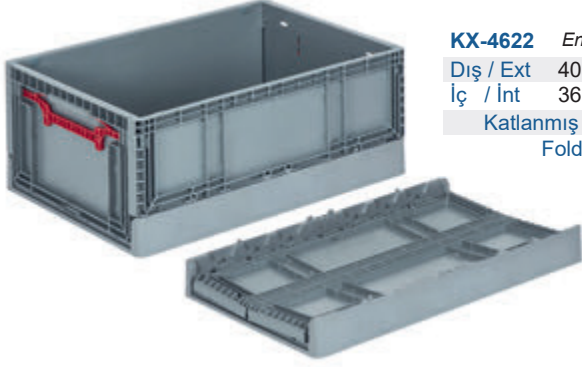

KX-4622 *En/W Boy/L Yük/H*
Dış / Ext 400 x 600 x 230 mm
İç / Int 365 x 560 x 220 mm
Katlanmış Yükseklik 73 mm
Folded Height 73 mm

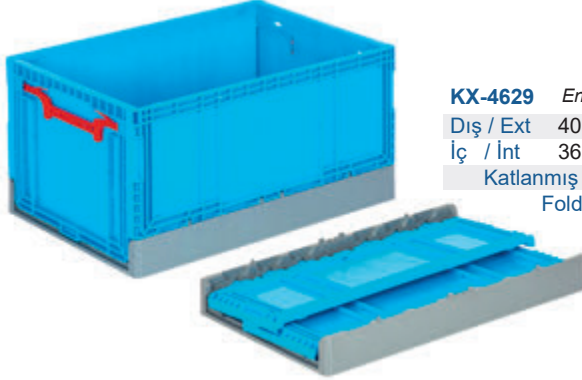

KX-4629 *En/W Boy/L Yük/H*
Dış / Ext 400 x 600 x 290 mm
İç / Int 365 x 560 x 280 mm
Katlanmış Yükseklik 73 mm
Folded Height 73 mm



KT-4322 *En/W Boy/L Yük/H*
Dış / Ext 296 x 395 x 230 mm
İç / Int 255 x 355 x 226 mm
Katlanmış Yükseklik 65 mm
Folded Height 65 mm



KT-4633 *En/W Boy/L Yük/H*
Dış / Ext 395 x 604 x 340 mm
İç / Int 364 x 562 x 326 mm
Katlanmış Yükseklik 80 mm
Folded Height 80 mm

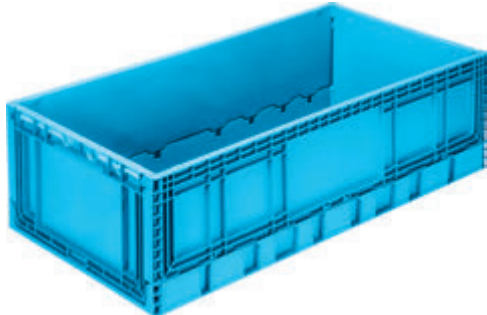

KT-4822-F *En/W Boy/L Yük/H*
Dış / Ext 400 x 800 x 230 mm
İç / Int 362 x 759 x 213 mm
Katlanmış Yükseklik 53 mm
Folded Height 53 mm



KT-8634 *En/W Boy/L Yük/H*
Dış / Ext 600 x 800 x 340 mm
İç / Int 565 x 764 x 334 mm
Katlanmış Yükseklik 80 mm
Folded Height 80 mm



Katlanır Delikli Kasalar
Folding Perforated Crates



PG-6411 En/W Boy/L Yük/H
Dış / Ext 400 x 600 x 115 mm
İç / Int 376 x 576 x 106 mm
Katlanmış Yükseklik 30 mm
Folded Height 30 mm



PG-6415 En/W Boy/L Yük/H
Dış / Ext 400 x 600 x 150 mm
İç / Int 376 x 576 x 141 mm
Katlanmış Yükseklik 30 mm
Folded Height 30 mm

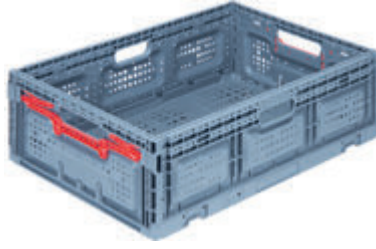

PG-6418 En/W Boy/L Yük/H
Dış / Ext 400 x 600 x 185 mm
İç / Int 362 x 576 x 176 mm
Katlanmış Yükseklik 32 mm
Folded Height 30 mm



PG-6422 En/W Boy/L Yük/H
Dış / Ext 400 x 600 x 219 mm
İç / Int 362 x 576 x 210 mm
Katlanmış Yükseklik 30 mm
Folded Height 30 mm

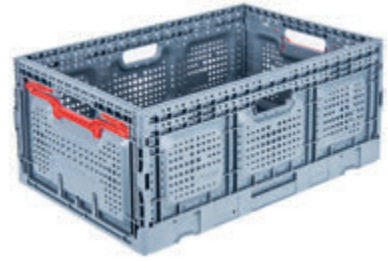
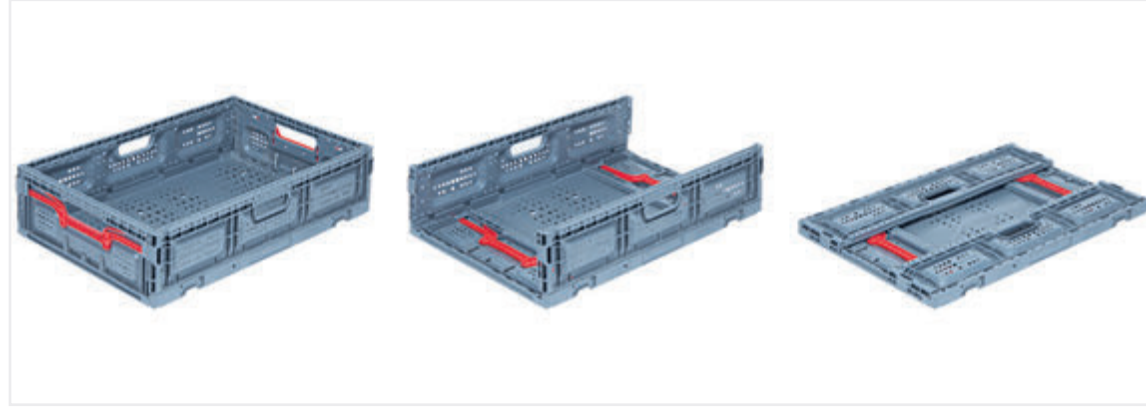

PG-6426 En/W Boy/L Yük/H
Dış / Ext 400 x 600 x 259 mm
İç / Int 376 x 576 x 251 mm
Katlanmış Yükseklik 47 mm
Folded Height 47 mm



KT-6416 En/W Boy/L Yük/H
Dış / Ext 400 x 600 x 157 mm
İç / Int 372 x 573 x 153 mm
Katlanmış Yükseklik 32 mm
Folded Height 32 mm



KT-6418 En/W Boy/L Yük/H
Dış / Ext 400 x 600 x 177 mm
İç / Int 372 x 573 x 173 mm
Katlanmış Yükseklik 32 mm
Folded Height 32 mm



KT-6420 En/W Boy/L Yük/H
Dış / Ext 400 x 600 x 197 mm
İç / Int 372 x 573 x 193 mm
Katlanmış Yükseklik 32 mm
Folded Height 32 mm



KT-6422 En/W Boy/L Yük/H
Dış / Ext 400 x 600 x 197 mm
İç / Int 372 x 573 x 193 mm
Katlanmış Yükseklik 32 mm
Folded Height 32 mm



Kapaklı Konik Kasalar

- Kapakları kapalıyken üstüste istiflenir ve taşınır.
- Kapakları açık iken içiçe geçerek yerden tasarruf sağlar.
- Konveyör sistemde kullanmaya uygundur.
- Eurobox standartlarına göre üretilmiştir.
- 4 Farklı yükseklikte olup üst üste istiflenebilmektedirler.
- Plastik kelepçe ve mühür uygulanabilirliği ile ürünlerinizin daha sağlıklı ve güvenilir taşınmasını sağlamaktadır.

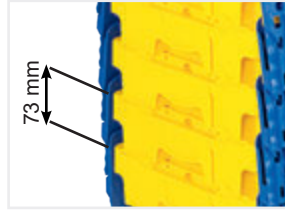

İççe İstifleme Yükseklik
Nesting height



ALC Attached Lid Crates

- Can be stacked and transported on top of each other when the lids are closed.
- When the lids are open, the nested design allows to save from the volume.
- Suitable for conveyor systems.
- Can be stacked with 4 different heights.
- Plastic cable tie and seal can be applied that your products are transported safely

300 x 400 Kapaklı Konik Kasalar

300 x 400 ALC Attached Lid Crates



HP-4321-MK En/W Boy/L Yük/H
Dış / Ext 300 x 400 x 210 mm
İç / Int 265 x 340 x 190 mm



HP-4325-MK En/W Boy/L Yük/H
Dış / Ext 300 x 400 x 250 mm
İç / Int 265 x 340 x 230 mm



HP-4332-MK En/W Boy/L Yük/H
Dış / Ext 300 x 400 x 320 mm
İç / Int 265 x 340 x 300 mm



HP-4336-MK En/W Boy/L Yük/H
Dış / Ext 300 x 400 x 365 mm
İç / Int 265 x 340 x 345 mm

400 x 600 Kapaklı Konik Kasalar

400 x 600 ALC Attached Lid Crates

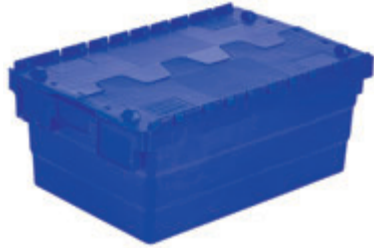

HP-6425-MK En/W Boy/L Yük/H
Dış / Ext 400 x 600 x 250 mm
İç / Int 365 x 543 x 232 mm

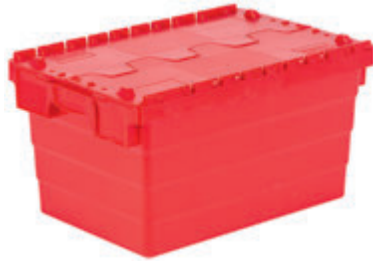

HP-6432-MK En/W Boy/L Yük/H
Dış / Ext 400 x 600 x 320 mm
İç / Int 365 x 545 x 302 mm



HP-6435-MK En/W Boy/L Yük/H
Dış / Ext 400 x 600 x 360 mm
İç / Int 365 x 545 x 347 mm



HP-6440-MK En/W Boy/L Yük/H
Dış / Ext 400 x 600 x 415 mm
İç / Int 365 x 545 x 398 mm



Tüm modellerimizde Pp levha seperatör uygulanabilir. PP sheet separators can be applied on all our designs .



Plastik Kelepçe Takılabilir.
Plastic cable tie can be applied



İççe İstifleme Yükseklik
Nesting height



Kapaklı Konik Kasaları
Nestable Crates



HX-2311-MK *En/W Boy/L Yük/H*
Dış / Ext 225 x 295 x 125 mm
İç / Int 200 x 270 x 108 mm



HX-2316-MK *En/W Boy/L Yük/H*
Dış / Ext 225 x 295 x 175 mm
İç / Int 200 x 270 x 158 mm



HX-5316-MK *En/W Boy/L Yük/H*
Dış / Ext 300 x 490 x 175 mm
İç / Int 257 x 430 x 155 mm



HX-5322-MK *En/W Boy/L Yük/H*
Dış / Ext 300 x 490 x 235 mm
İç / Int 257 x 430 x 210 mm



HX-5326-MK *En/W Boy/L Yük/H*
Dış / Ext 300 x 490 x 275 mm
İç / Int 257 x 430 x 255 mm



HX-5311 *En/W Boy/L Yük/H*
Dış / Ext 300 x 490 x 110 mm
İç / Int 257 x 430 x 107 mm



HX-5316 *En/W Boy/L Yük/H*
Dış / Ext 300 x 490 x 160 mm
İç / Int 257 x 430 x 155 mm



HX-5322 *En/W Boy/L Yük/H*
Dış / Ext 300 x 490 x 220 mm
İç / Int 257 x 430 x 210 mm



HX-5326 *En/W Boy/L Yük/H*
Dış / Ext 300 x 490 x 260 mm
İç / Int 257 x 430 x 255 mm

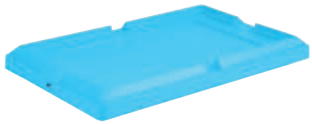

HX-5300 *En/W Boy/L Yük/H*
Dış / Ext 310 x 503 x 50 mm
300 x 500 Kapak / Lid



HX-1607 *En/W Boy/L Yük/H*
Dış / Ext 160 x 220 x 70 mm
İç / Int 134 x 194 x 68 mm



HX-1611 *En/W Boy/L Yük/H*
Dış / Ext 160 x 220 x 114 mm
İç / Int 134 x 194 x 112 mm



HX-2311 *En/W Boy/L Yük/H*
Dış / Ext 225 x 295 x 110 mm
İç / Int 200 x 270 x 108 mm



HX-2316 *En/W Boy/L Yük/H*
Dış / Ext 225 x 295 x 160 mm
İç / Int 200 x 270 x 158 mm

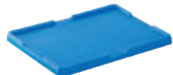

HX-1600 *En/W Boy/L Yük/H*
Dış / Ext 164 x 224 x 10 mm
160 x 220 Kapak / Lid

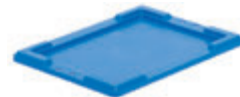

HX-2300 *En/W Boy/L Yük/H*
Dış / Ext 230 x 302 x 15 mm
225 x 295 Kapak / Lid



600x800 mm Kasaları
600x800 mm Crates



Kod / Code **AX-8611**
En/W Boy/L Yük/H
Dış / Ext 600 x 800 x 119 mm
İç / Int 559 x 753 x 107 mm



Kod / Code **AX-8616**
En/W Boy/L Yük/H
Dış / Ext 600 x 800 x 174 mm
İç / Int 555 x 750 x 162 mm



Kod / Code **AX-8622**
En/W Boy/L Yük/H
Dış / Ext 600 x 800 x 230 mm
İç / Int 555 x 750 x 215 mm



Kod / Code **AX-8633**
En/W Boy/L Yük/H
Dış / Ext 600 x 800 x 340 mm
İç / Int 555 x 750 x 325 mm



Kod / Code **H-8638**
En/W Boy/L Yük/H
Dış / Ext 600 x 800 x 388 mm
İç / Int 555 x 748 x 374 mm



Kod / Code **AX-8644**
En/W Boy/L Yük/H
Dış / Ext 600 x 800 x 450 mm
İç / Int 552 x 747 x 435 mm



Kod / Code **HP-61X81**
Dış / Ext 600 x 800 x 20 mm
600x800 mm Kasalara uyumlu kapak
Lid for 600X800 mm Crates



Kod / Code **AX-8622-MK**
En/W Boy/L Yük/H
Dış / Ext 600 x 800 x 250 mm
İç / Int 555 x 750 x 215 mm



Kod / Code **AX-8633-MK**
En/W Boy/L Yük/H
Dış / Ext 600 x 800 x 360 mm
İç / Int 555 x 750 x 325 mm



YM-60X80 En/W Boy/L Yük/H
Dış / Ext 620 x 820 x 160 mm
600 X 800 Metal kasa taşıma arabası
600 X 800 mm Metal dolly



Kod / Code **AX-8644-MK**
En/W Boy/L Yük/H
Dış / Ext 600 x 800 x 450 mm
İç / Int 555 x 750 x 435 mm

600x800 mm Kasaları
600x800 mm Crates



Kod / Code **AX-8639**
En/W Boy/L Yük/H
Dış / Ext 600 x 800 x 390 mm
İç / Int 565 x 760 x 330 mm



Kod / Code **AX-8650**
En/W Boy/L Yük/H
Dış / Ext 600 x 800 x 500 mm
İç / Int 565 x 760 x 435 mm

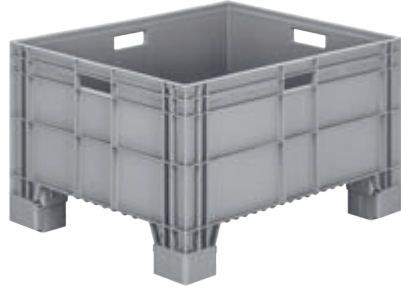

Kod / Code **AX-8639-X**
En/W Boy/L Yük/H
Dış / Ext 600 x 800 x 470 mm
İç / Int 565 x 760 x 330 mm

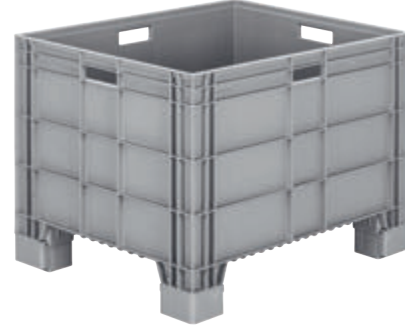

Kod / Code **AX-8650-X**
En/W Boy/L Yük/H
Dış / Ext 600 x 800 x 580 mm
İç / Int 565 x 760 x 435 mm

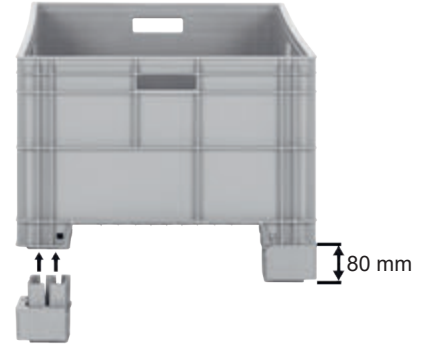

Kod / Code **AX-86 AYK**
En/W Boy/L Yük/H
Dış / Ext 60 x 50 x 80 mm
AX-8650 ve AX-8639 uyumlu 80 mm yükseltme takozu, transpalet ve forkliftle kullanılmasını sağlar. 80 mm rising wedges are compatible with AX-8650 and AX-8639 and are used to make crates compatible with transpallet and forklift



Kod / Code **AX-8639-T**
En/W Boy/L Yük/H
Dış / Ext 600 x 800 x 520 mm
İç / Int 565 x 770 x 330 mm



Kod / Code **AX-8650-T**
En/W Boy/L Yük/H
Dış / Ext 600 x 800 x 630 mm
İç / Int 565 x 760 x 435 mm

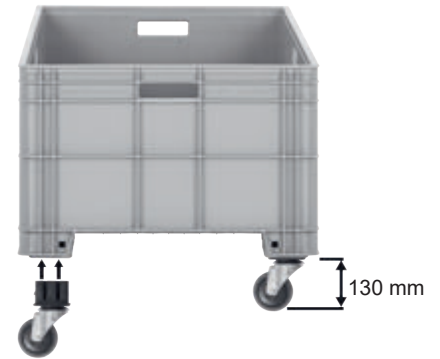

Kod / Code **AX-86-T**
En/W Boy/L Yük/H
Dış / Ext 60 x 50 x 130 mm
AX-8650 ve AX-8639 uyumlu teker.
Compatible wheels for AX-8650 and Ax-8639

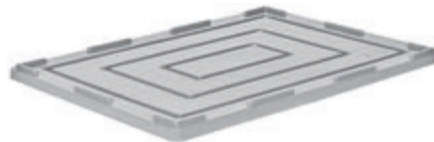

HP-61X81 En/W Boy/L Yük/H
620 x 820 x 20 mm
610x800 mm Kasalara uyumlu kapak
Lid for 610x810 mm Crates

400 x 800 Kasalar
400 x 800 Crates



Kod / Code H-4811
En/W Boy/L Yük/H
Dış / Ext 400 x 800 x 119 mm
İç / Int 356 x 758 x 109 mm

400 x 1200 Kasalar
400 x 1200 Crates



Kod / Code AX-4111
En/W Boy/L Yük/H
Dış / Ext 400 x 1200 x 119 mm
İç / Int 358 x 1157 x 108 mm



Kod / Code H-4816
En/W Boy/L Yük/H
Dış / Ext 400 x 800 x 171 mm
İç / Int 352 x 752 x 158 mm

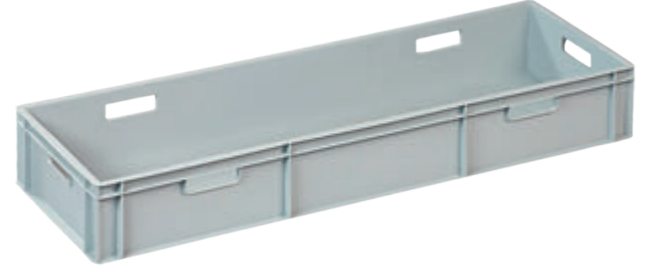

Kod / Code AX-4116
En/W Boy/L Yük/H
Dış / Ext 400 x 1200 x 171 mm
İç / Int 354 x 1154 x 158 mm



Kod / Code H-4822
En/W Boy/L Yük/H
Dış / Ext 400 x 800 x 227 mm
İç / Int 352 x 752 x 215 mm



Kod / Code AX-4122
En/W Boy/L Yük/H
Dış / Ext 400 x 1200 x 230 mm
İç / Int 354 x 1154 x 215 mm



Kod / Code H-4828
En/W Boy/L Yük/H
Dış / Ext 400 x 800 x 278 mm
İç / Int 348 x 748 x 265 mm



Kod / Code AX-4133
En/W Boy/L Yük/H
Dış / Ext 400 x 1200 x 338 mm
İç / Int 350 x 1154 x 324 mm



Kod / Code YM-4080
En/W Boy/L Yük/H
Dış / Ext 420 x 820 x 150 mm
Metal kasa taşıyıcı / Metal dolly



Kod / Code YM-4120
En/W Boy/L Yük/H
Dış / Ext 420 x 1220 x 150 mm
Metal kasa taşıyıcı / Metal dolly

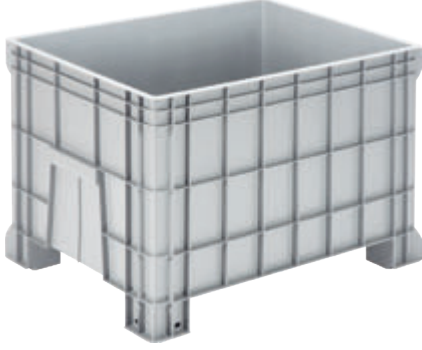

K-330 En/W Boy/L Yük/H
Dış / Ext 670 x 930 x 625 mm
İç / İnt 620 x 890 x 520 mm



K-330 T En/W Boy/L Yük/H
Dış / Ext 670 x 930 x 770 mm
İç / İnt 620 x 890 x 520 mm



K-370	En/W Boy/L Yük/H	Hacim	Dynamic	Static
Dış / Ext	640 x 1000 x 550 mm	Volume	Capacity	Capacity
İç / İnt	585 x 932 x 395 mm	200 Lt	300 Kg	1800 Kg
Kapalı / Closed	Ağırlık / Weight	10,50 kg		



K-370 T	En/W Boy/L Yük/H	Hacim	Dynamic	Static
Dış / Ext	640 x 1000 x 667 mm	Volume	Capacity	Capacity
İç / İnt	585 x 932 x 395 mm	200 Lt	300 Kg	1800 Kg
Kapalı / Closed	Ağırlık / Weight	12,50 kg		

Kapalı Konteynerler
Closed Containers



K-400	En/W	Boy/L	Yük/H	Hacim	Dynamic	Static
Dış / Ext	636 x	1017 x	673 mm	Volume	Capacity	Capacity
İç / Int	585 x	932 x	512 mm	270 Lt	300 Kg	1800 Kg
Kapalı / Closed	Ağırlık / Weight			12,00 kg		



K-400 T	En/W	Boy/L	Yük/H	Hacim	Dynamic	Static
Dış / Ext	636 x	1017 x	790 mm	Volume	Capacity	Capacity
İç / Int	585 x	932 x	512 mm	270 Lt	300 Kg	1800 Kg
Kapalı / Closed	Ağırlık / Weight			14,50 kg		

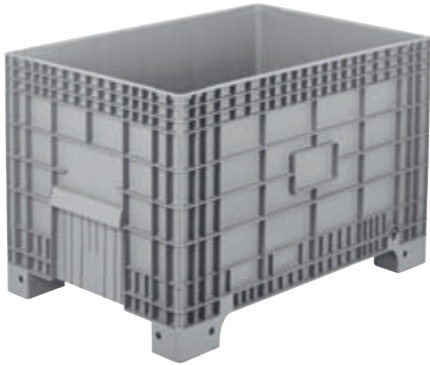

K-550	En/W	Boy/L	Yük/H	Hacim	Dynamic	Static
Dış / Ext	800 x	1200 x	800 mm	Volume	Capacity	Capacity
İç / Int	732 x	1106 x	617 mm	500 Lt	400 Kg	2500 Kg
Kapalı / Closed	Ağırlık / Weight			22,00 kg		



K-550 T	En/W	Boy/L	Yük/H	Hacim	Dynamic	Static
Dış / Ext	800 x	1200 x	925 mm	Volume	Capacity	Capacity
İç / Int	732 x	1108 x	617 mm	500 Lt	400 Kg	2500 Kg
Kapalı / Closed	Ağırlık / Weight			25,50 kg		



HP-65x100 En/W Boy/L Yük/H
Dış / Ext 650 x 1050 x 54 mm
K-370 ve K-400 uyumlu kapak
Lid for K-370 and K-400



HP-82x120 En/W Boy/L Yük/H
Dış / Ext 805 x 1270 x 60 mm
K-550 uyumlu kapak
Lid for K-550

Kapalı Konteynerler
Closed Containers



K-6500-K	En/W Boy/L Yük/H	Hacim	Dynamic	Static
Dış / Ext	1000 x 1200 x 580 mm	Volume	Capacity	Capacity
İç / İnt	920 x 1120 x 430 mm	450 Lt	700 Kg	4000 Kg
Kapalı / Closed	Ağırlık / Weight	29,50 kg		



K-6500-KT	En/W Boy/L Yük/H	Hacim	Dynamic	Static
Dış / Ext	1000 x 1200 x 730 mm	Volume	Capacity	Capacity
İç / İnt	920 x 1120 x 430 mm	450 Lt	700 Kg	1000 Kg
Kapalı / Closed	Ağırlık / Weight	34,00 kg		



K-6600-K	En/W Boy/L Yük/H	Hacim	Dynamic	Static
Dış / Ext	1000 x 1200 x 760 mm	Volume	Capacity	Capacity
İç / İnt	920 x 1120 x 610 mm	450 Lt	700 Kg	4000 Kg
Kapalı / Closed	Ağırlık / Weight	36,00 kg		



K-6600-KT	En/W Boy/L Yük/H	Hacim	Dynamic	Static
Dış / Ext	1000 x 1200 x 910 mm	Volume	Capacity	Capacity
İç / İnt	920 x 1120 x 610 mm	625 Lt	700 Kg	1000 Kg
Kapalı / Closed	Ağırlık / Weight	41,00 kg		



K-6700-K	En/W Boy/L Yük/H	Hacim	Dynamic	Static
Dış / Ext	1000 x 1200 x 850 mm	Volume	Capacity	Capacity
İç / İnt	920 x 1120 x 700 mm	720 Lt	700 Kg	4000 Kg
Kapalı / Closed	Ağırlık / Weight	38,00 kg		



K-6700-KT	En/W Boy/L Yük/H	Hacim	Dynamic	Static
Dış / Ext	1000 x 1200 x 1000 mm	Volume	Capacity	Capacity
İç / İnt	920 x 1120 x 700 mm	720 Lt	700 Kg	1000 Kg
Kapalı / Closed	Ağırlık / Weight	43,00 kg		



K-6800-K	En/W Boy/L Yük/H	Hacim	Dynamic	Static
Dış / Ext	1000 x 1200 x 920 mm	Volume	Capacity	Capacity
İç / İnt	890 x 1110 x 730 mm	700 Lt	700 Kg	2500 Kg
Kapalı / Closed				



K-6800-2KZ	En/W Boy/L Yük/H	Hacim	Dynamic	Static
Dış / Ext	1000 x 1200 x 920 mm	Volume	Capacity	Capacity
İç / İnt	890 x 1110 x 730 mm	700 Lt	700 Kg	2500 Kg
Kapalı / Closed				

Delikli Konteynerler
Perforated Containers



K-6500-A	<i>En/W Boy/L Yük/H</i>	Hacim	Dynamic	Static
Dış / Ext	1000 x 1200 x 580 mm	Volume	Capacity	Capacity
İç / Int	920 x 1120 x 430 mm	450 Lt	700 Kg	4000 Kg
Delikli / Perforated	Ağırlık / Weight	28,00 kg		



K-6500-AT	<i>En/W Boy/L Yük/H</i>	Hacim	Dynamic	Static
Dış / Ext	1000 x 1200 x 730 mm	Volume	Capacity	Capacity
İç / Int	920 x 1120 x 430 mm	450 Lt	700 Kg	4000 Kg
Delikli / Perforated	Ağırlık / Weight	33,00 kg		



K-6600-A	<i>En/W Boy/L Yük/H</i>	Hacim	Dynamic	Static
Dış / Ext	1000 x 1200 x 760 mm	Volume	Capacity	Capacity
İç / Int	920 x 1120 x 610 mm	625 Lt	700 Kg	4000 Kg
Delikli / Perforated	Ağırlık / Weight	34,00 kg		



K-6600-AT	<i>En/W Boy/L Yük/H</i>	Hacim	Dynamic	Static
Dış / Ext	1000 x 1200 x 910 mm	Volume	Capacity	Capacity
İç / Int	920 x 1120 x 610 mm	625 Lt	700 Kg	4000 Kg
Delikli / Perforated	Ağırlık / Weight	39,00 kg		



K-6700-A	<i>En/W Boy/L Yük/H</i>	Hacim	Dynamic	Static
Dış / Ext	1000 x 1200 x 850 mm	Volume	Capacity	Capacity
İç / Int	920 x 1120 x 700 mm	720 Lt	700 Kg	4000 Kg
Delikli / Perforated	Ağırlık / Weight	36,00 kg		



K-6700-AT	<i>En/W Boy/L Yük/H</i>	Hacim	Dynamic	Static
Dış / Ext	1000 x 1200 x 1000 mm	Volume	Capacity	Capacity
İç / Int	920 x 1120 x 700 mm	720 Lt	700 Kg	4000 Kg
Delikli / Perforated	Ağırlık / Weight	41,00 kg		



HP-102X120	<i>En/W Boy/L Yük/H</i>
Dış / Ext	1020 x 1200 x 60 mm
K-6500, K-6600 ve K-6700 Uyumlu Kapak Lid for K-6500, K-6600 and K-6700	

Katlanır Konteynerler
Folding Containers



KT-1210-A	En/W Boy/L Yük/H	Hacim	Dynamic	Static
Dış / Ext	1000 x 1200 x 800 mm	Volume	Capacity	Capacity
İç / Int	920 x 1120 x 650 mm	670 Lt	500 Kg	5000 Kg
Katlanmış Yükseklik / Folded Height		290 mm		
Delikli / Perforated	Ağırlık / Weight	41 kg+/- %3		



KT-1210-K	En/W Boy/L Yük/H	Hacim	Dynamic	Static
Dış / Ext	1000 x 1200 x 800 mm	Volume	Capacity	Capacity
İç / Int	920 x 1120 x 650 mm	670 Lt	500 Kg	5000 Kg
Katlanmış Yükseklik / Folded Height		290 mm		
Kapalı / Closed	Ağırlık / Weight	42 kg+/- %3		

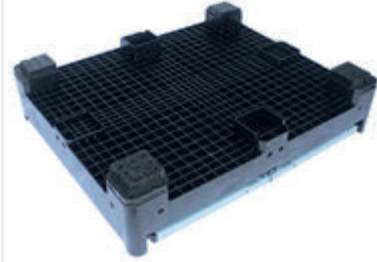

Standart 4 Ayak
Standard 4 Feet



KT-1212-A	En/W Boy/L Yük/H	Hacim	Dynamic	Static
Dış / Ext	1200 x 1200 x 800 mm	Volume	Capacity	Capacity
İç / Int	1120 x 1120 x 650 mm	820 Lt	500 Kg	5000 Kg
Katlanmış Yükseklik / Folded Height		290 mm		
Delikli / Perforated	Ağırlık / Weight	44 kg+/- %3		



Aksesuar 2 Kızak
Optional 2 Runners



KT-1212-K	En/W Boy/L Yük/H	Hacim	Dynamic	Static
Dış / Ext	1200 x 1200 x 800 mm	Volume	Capacity	Capacity
İç / Int	1120 x 1120 x 650 mm	820 Lt	500 Kg	5000 Kg
Katlanmış Yükseklik / Folded Height		290 mm		
Kapalı / Closed	Ağırlık / Weight	45 kg+/- %3		



Aksesuar Flap Kapak
Optional Flap



80-120-A EKO KZ	Static Capacity	Dynamic Capacity	Raf Capacity	Ağırlık Weight
En/W Boy/L Yük/H 800 x 1200 x 150 mm	2000 Kg	1250 Kg	500 Kg	8,20 Kg +/- %3



100-120-A EKO KZ	Static Capacity	Dynamic Capacity	Raf Capacity	Ağırlık Weight
En/W Boy/L Yük/H 800 x 1200 x 150 mm	2000 Kg	1250 Kg	500 Kg	9,80 Kg +/- %3



80-120-K EKO KZ	Static Capacity	Dynamic Capacity	Raf Capacity	Ağırlık Weight
En/W Boy/L Yük/H 800 x 1200 x 150 mm	2000 Kg	1250 Kg	500 Kg	9,50 Kg +/- %3



100-120-K EKO KZ	Static Capacity	Dynamic Capacity	Raf Capacity	Ağırlık Weight
En/W Boy/L Yük/H 1000 x 1200 x 150 mm	2500 Kg	1250 Kg	500 Kg	11,40 Kg +/- %3

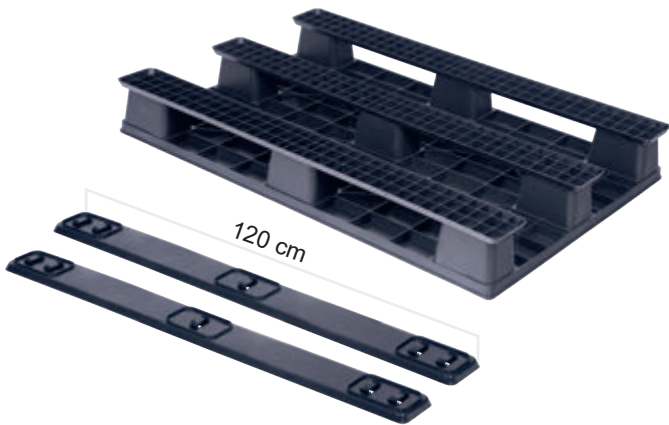

110-110 A	Static Capacity	Dynamic Capacity	Ağırlık Weight
En/W Boy/L Yük/H 1100 x 1100 x 150 mm	4000 Kg	1500 Kg	13,00 Kg

EKO KZ
80-120-A EKO KZ, 100-120-A EKO KZ
80-120-K EKO KZ, 100-120-K EKO KZ
Paletler ile uyumludur
Compatible with

Tek yön paletler
One-Way Pallets



80-120-A EKO	Static Capacity	Dynamic Capacity	Ağırlık Weight
En/W Boy/L Yük/H 800 x 1200 x 134 mm	2000 Kg	1000 Kg	7,00 Kg



100-120-A EKO	Static Capacity	Dynamic Capacity	Ağırlık Weight
En/W Boy/L Yük/H 1000 x 1200 x 134 mm	2000 Kg	1000 Kg	8,40 Kg



80-120-K EKO	Static Capacity	Dynamic Capacity	Ağırlık Weight
En/W Boy/L Yük/H 800 x 1200 x 134 mm	2000 Kg	1000 Kg	7,80 Kg



100-120-K EKO	Static Capacity	Dynamic Capacity	Ağırlık Weight
En/W Boy/L Yük/H 1000 x 1200 x 134 mm	2000 Kg	1000 Kg	10,00 Kg



60-80 A	Static Capacity	Dynamic Capacity	Ağırlık Weight
En/W Boy/L Yük/H 600 x 800 x 134 mm	1000 Kg	500 Kg	2,50 Kg



Kimyasal madde boşaltma musluğu
Chemical Discharging nozzle

Kod / Code **VPP-80X120**

Dış / Ext 800 x 1200 x 355 mm

Gövde metal içi plastik varil paleti
Trunk metal plastic barrel palette

Tek yön paletler
One-Way Pallets



80-120 XE	Static Capacity	Dynamic Capacity	Ağırlık Weight
<i>En/W Boy/L Yük/H</i> 800 x 1200 x 130 mm	1500 Kg	400 Kg	4,00 Kg

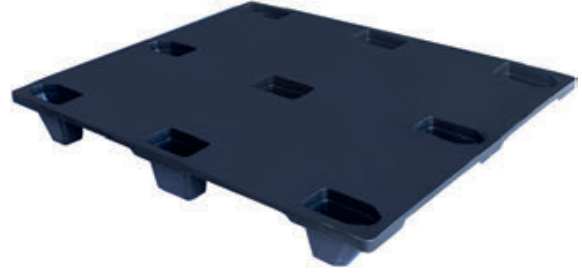

80-120 XEP	Static Capacity	Dynamic Capacity	Ağırlık Weight
<i>En/W Boy/L Yük/H</i> 800 x 1200 x 130 mm	1500 Kg	400 Kg	5,20 Kg



100-120 XE	Static Capacity	Dynamic Capacity	Ağırlık Weight
<i>En/W Boy/L Yük/H</i> 1000 x 1200 x 130 mm	1500 Kg	400 Kg	4,70 Kg

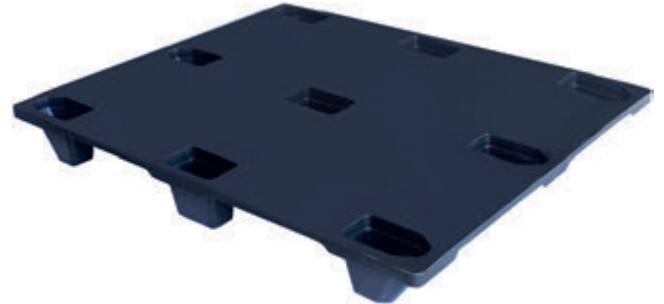

100-120 XEP	Static Capacity	Dynamic Capacity	Ağırlık Weight
<i>En/W Boy/L Yük/H</i> 1000 x 1200 x 130 mm	1500 Kg	400 Kg	6,20 Kg



Kızak 120 / SKID 120
80-120 XE, 80-120 XEP, 100-120 XE
100-120 XEP, Paletler ile uyumludur
Compatible with 80-120 XE, 80-120
XEP, 100-120 XE 100-120 XEP, Pallets



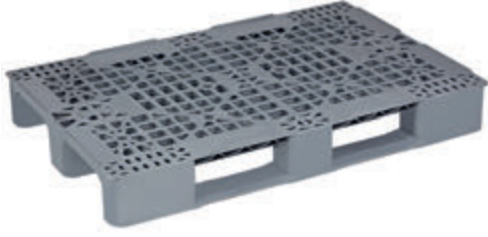

80-120 Üstü Delikli / Perforated	Static Capacity	Dynamic Capacity	Raf Capacity
En/W Boy/L Yük/H 800 x 1200 x 150 mm	3000 Kg	1000 Kg	600 Kg



80-120 K Üstü Kapalı / Closed	Static Capacity	Dynamic Capacity	Raf Capacity
En/W Boy/L Yük/H 800 x 1200 x 150 mm	3000 Kg	1000 Kg	600 Kg

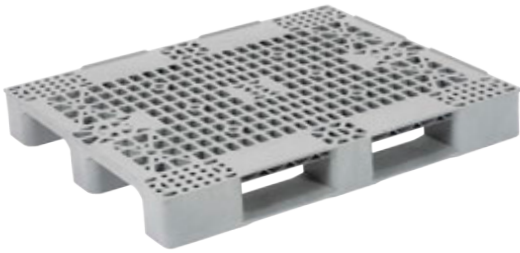

100-120 Üstü Delikli / Perforated	Static Capacity	Dynamic Capacity	Raf Capacity
En/W Boy/L Yük/H 1000 x 1200 x 150 mm	3000 Kg	1000 Kg	600 Kg



100-120 K Üstü Kapalı / Closed	Static Capacity	Dynamic Capacity	Raf Capacity
En/W Boy/L Yük/H 1000 x 1200 x 150 mm	3000 Kg	1000 Kg	600 Kg

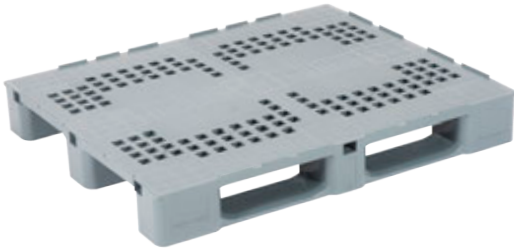

80-120 MW-P Profil Yuvalı / Profile Slot	Static Capacity	Dynamic Capacity	Raf Capacity
En/W Boy/L Yük/H 800 x 1200 x 150 mm	5000 Kg	1500 Kg	900 Kg
	Ağırlık / Weight	14.00 Kg	



80-120 MP-P Profil Yuvalı / Profile Slot	Static Capacity	Dynamic Capacity	Raf Capacity
En/W Boy/L Yük/H 800 x 1200 x 150 mm	5000 Kg	1500 Kg	900 Kg
	Ağırlık / Weight	15.00 Kg	



60-80 K	Static Capacity	Dynamic Capacity
En/W Boy/L Yük/H 600 x 800 x 150 mm	2000 Kg	500 Kg
	Ağırlık / Weight	5,40 Kg



60-80 3K	Static Capacity	Dynamic Capacity
En/W Boy/L Yük/H 600 x 800 x 160 mm	2000 Kg	1000 Kg
	Ağırlık / Weight	5,60 Kg

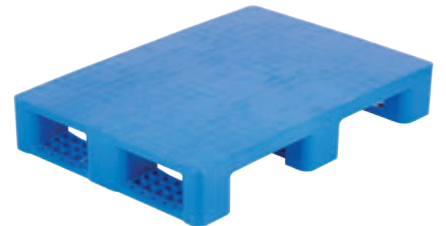

70-100 K	Static Capacity	Dynamic Capacity
En/W Boy/L Yük/H 700 x 1000 x 150 mm	1000 Kg	500 Kg
	Ağırlık / Weight	8,45 Kg

Kapaklı Sanayi Kasaları



80-120 hij üstü kapalı 3 kızaklı palet / Closed En/W Boy/L Yük/H	Static Capacity	Dynamic Capacity	Raf Capacity
800 x 1200 x 160 mm	5000 Kg	1250 Kg	1000 Kg
	Ağırlık / Weight 18,00 Kg		



100-120 hij üstü kapalı 3 kızaklı palet / Closed En/W Boy/L Yük/H	Static Capacity	Dynamic Capacity	Raf Capacity
1000 x 1200 x 160 mm	7500 Kg	1500 Kg	1250 Kg
	Ağırlık / Weight 21,00 Kg		



100-120 hij 5 üstü kapalı 5 kızaklı palet / Closed En/W Boy/L Yük/H	Static Capacity	Dynamic Capacity	Raf Capacity
1000 x 1200 x 160 mm	7500 Kg	1500 Kg	1250 Kg
	Ağırlık / Weight 22,00 Kg		

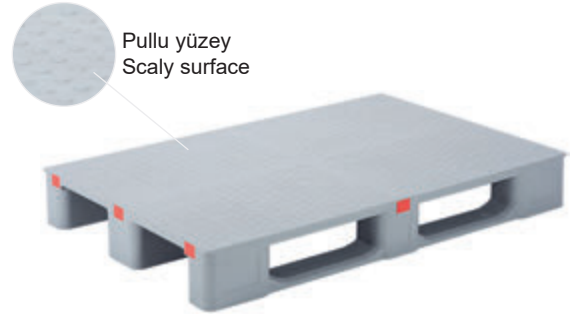

80-120 MRC Pullu yüzeyli palet Scaly surface Pallet En/W Boy/L Yük/H	Static Capacity	Dynamic Capacity	Raf Capacity
800 x 1200 x 150 mm	5000 Kg	1500 Kg	900 Kg
	Ağırlık / Weight 15,00 Kg		



HP-83X120
En/W Boy/L Yük/H
805 x 1270 x 55 mm
80-120 Paleta uyumlu kapak / Lid for 80-120 Pallet



HP-103X120
En/W Boy/L Yük/H
1050 x 1200 x 65 mm
100-120 Paleta uyumlu kapak / Lid for 100-120 Pallet

TKZ-39 En/W Boy/L Yük/H
39 x 390 x 70 mm
80-120-MR Uyumlu Takoz
Wedges



80-120 MRP Profil Yapılı / Profile Structure En/W Boy/L Yük/H	Static Capacity	Dynamic Capacity	Raf Capacity
800 x 1200 x 150 mm	5000 Kg	1500 Kg	900 Kg
	Ağırlık / Weight 15,00 Kg		



ÇK-20 25 Lt.
En/W Boy/L Yük/H
Dış / Ext 310 x 350 x 440 mm
Koli Adedi / In Box : 4 Ad / Pcs



ÇK-30 40 Lt.
En/W Boy/L Yük/H
Dış / Ext 360 x 390 x 440 mm
Koli Adedi / In Box : 5 Ad / Pcs



ÇK-65 65 Lt.
En/W Boy/L Yük/H
Dış / Ext 470 x 400 x 630 mm
Koli Adedi / In Box : 5 Ad / Pcs



ÇK-85 85 Lt.
En/W Boy/L Yük/H
Dış / Ext 470 x 450 x 730 mm
Koli Adedi / In Box : 5 Ad / Pcs



ÇK-4280 10 Lt.
En/W Boy/L Yük/H
Dış / Ext 200 x 275 x 350 mm
Koli Adedi / In Box : 12 Ad / Pcs



ÇK-4281 15 Lt.
En/W Boy/L Yük/H
Dış / Ext 260 x 365 x 400 mm
Koli Adedi / In Box : 12 Ad / Pcs



ÇK-4282 25 Lt.
En/W Boy/L Yük/H
Dış / Ext 260 x 365 x 475 mm
Koli Adedi / In Box : 6 Ad / Pcs



ÇK-4283 40 Lt.
En/W Boy/L Yük/H
Dış / Ext 300 x 430 x 550 mm
Koli Adedi / In Box : 5 Ad / Pcs



ÇK-4284 60 Lt.
En/W Boy/L Yük/H
Dış / Ext 340 x 480 x 630 mm
Koli Adedi / In Box : 5 Ad / Pcs



ÇK-500 240 Lt.
En/W Boy/L Yük/H
Dış / Ext 585 x 730 x 1100 mm



ÇK-600 360 Lt.
En/W Boy/L Yük/H
Dış / Ext 620 x 865 x 1100 mm



ÇK-660 660 Lt.
En/W Boy/L Yük/H
Dış / Ext 1200 x 780 x 1200 mm



ÇK-770 770 Lt.
En/W Boy/L Yük/H
Dış / Ext 1370 x 795 x 1310 mm



ÇK-1100 1100 Lt.
En/W Boy/L Yük/H
Dış / Ext 1360 x 1360 x 1330 mm

ÇK-400 Çöp Kovası ÇK-400 Waste Bins



ÇK-400 M



ÇK-400 K



ÇK-400 O

ÇK-400 Çöp Kovası
ÇK-400 Waste Bins

En/W Boy/L Yük/H

Dış / Ext. 480 x 530 x 990 mm

Hacim / Volume 120 Lt.



ÇK-400 S



ÇK-400 KH



ÇK-400 Si



ÇK-400 G

Farklı Renkli Kapaklar
Different colored lids



ÇK-400 GK

ÇK-400 GS

ÇK-400 GM

ÇK-400 GT

ÇK-400 GY



ÇK-400 P

120 Lt.

Dış / Ext 480 x 530 x 950 mm



ÇK-400 D

120 Lt.

Dış / Ext 480 x 530 x 950 mm



Üstü delikli kapak
Perforated Lid



ÇK-400 PEA

En/W Boy/L Yük/H

Dış / Ext 480 x 530 x 990 mm

120 Lt.



ÇK-400 EA

En/W Boy/L Yük/H

Dış / Ext 480 x 530 x 990 mm

120 Lt.

Sıfır Atık Geri Dönüşüm Kutuları
Zero Waste Recycling Bins

ÇK-400 Sıfır Atık Konteynerleri
ÇK-400 Zero Waste Containers

En/W Boy/L Yük/H

Dış / Ext. 480 x 530 x 990 mm

Hacim / Volume 120 Lt.



ÇK-400 YCA
CAM ATIK
GLASS WASTE



ÇK-400 OTI
TIBBİ ATIK
MEDICAL WASTE



ÇK-400 KTA
TEHLİKELİ ATIK
DANGEROUS
WASTE



ÇK-400 SPA
PLASTİK ATIK
PLASTIC WASTE



ÇK-400 KHO
ORGANİK ATIK
ORGANIC WASTE



ÇK-400 GMA
METAL ATIK
METAL WASTE



ÇK-400 SIG
GERİ DÖNÜŞMEYEN ATIK
NON-RECYCLABLE WASTE



ÇK-400 MKA
KAĞIT ATIK
PAPER WASTE

Sticker'lı Modeller / Models With Stickers



ÇM70-CM
CAM
GLASS



ÇK-70-PS
PLASTİK
PLASTIC



ÇK-70-MT
METAL



ÇK-70-KG
KAĞIT
PAPER



ÇK-70-OA
ORGANİK
ORGANIC



ÇK-70-DA
GERİ
DÖNÜŞTÜRÜLEMİYEN
NOT RECYCLED

ÇK-70 En/W Boy/L Yük/H
Dış / Ext 402 x 362 x 721 mm
70 Lt.

Sticker'lı Modeller / Models With Stickers



ÇK-50-PS
PLASTİK / PLASTIC



ÇK-50-KG
KAĞIT / PAPER



ÇK-50-MT
METAL



ÇK-50-CM
CAM / GLASS



ÇK-50-EA
ENFEKTE INFECTED

ÇK-50 Sıfır En/W Boy/L Yük/H
Dış / Ext 460 x 360 x 550 mm
50 Lt.



ÇK-1825 4'lü Atık Kovası / Metal waste bins set
En/W Boy/L Yük/H
Dış / Ext 750 x 320 x 640 mm



ÇK-1812 4'lü Atık Kovası / Metal waste bins set
En/W Boy/L Yük/H
Dış / Ext 1150 x 300 x 650 mm



ÇK-1811 3'lü Atık Kovası / Metal waste bins set
En/W Boy/L Yük/H
Dış / Ext 1230 x 420 x 1050 mm



ES-35
Dış Mekan Plastik Sulu Küllük



ÇK-1801 Atık Kovası
Metal waste bin
En/W Yük/H
Dış / Ext 240 x 600 mm
Paslanmaz / Stainless



ÇK-1805 Atık Kovası
Metal waste bin
En/W Yük/H
Dış / Ext 350 x 1000 mm
Paslanmaz / Stainless

Enfekte Atık Kovaları / Infected Waste Bins



ÇK-400 PEA
En/W Boy/L Yük/H
Dış / Ext 480 x 530 x 990 mm
120 Lt.



ÇK-400 EA
En/W Boy/L Yük/H
Dış / Ext 480 x 530 x 990 mm
120 Lt.



ÇK-85 EA
En/W Boy/L Yük/H
Dış / Ext 470 x 450 x 730 mm
85 Lt.



ÇK-65 EA
En/W Boy/L Yük/H
Dış / Ext 470 x 400 x 630 mm
65 Lt.



ÇK-4284 EA
En/W Boy/L Yük/H
Dış / Ext 350 x 490 x 620 mm
60 Lt.

brc

PLASTİK



2023 PLASTİK ÜRÜNLER KATALOĞU
PLASTIC PRODUCTS CATALOG

www.brc.com.tr

Çekmeköy / İstanbul, M. Kemalpaşa / Bursa ☎ : 0532 708 41 30